

**Split Dual Si/SiC  
 Hybrid IGBT Module  
 100 Amperes/1200 Volts**

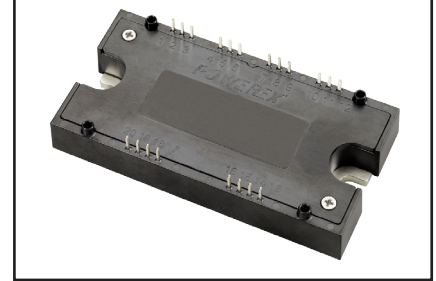
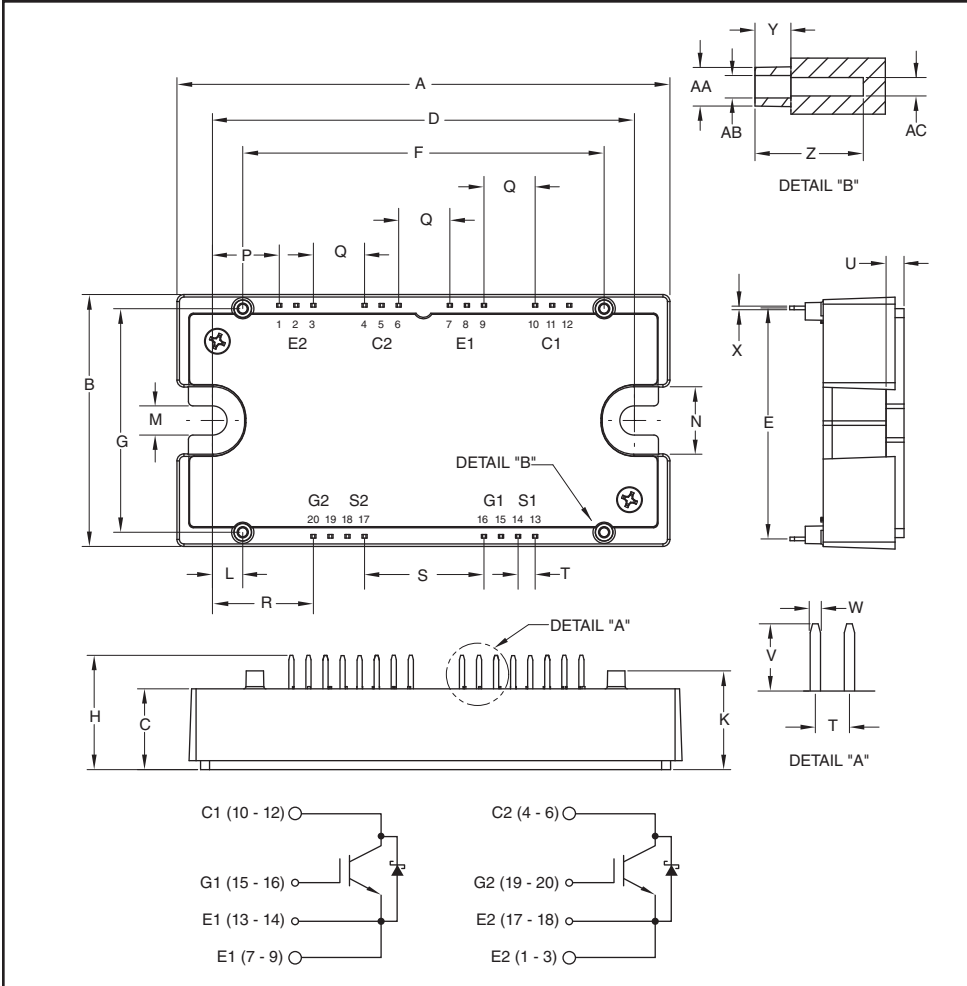

**Description:**

Powerex IGBT Modules are designed for use in high frequency applications; upwards of 30 kHz for hard switching applications and 80 kHz for soft switching applications. Each module consists of two IGBT Transistors with each transistor having a reverse-connected super-fast recovery free-wheel silicon carbide Schottky diode. All components and interconnects are isolated from the heat sinking baseplate, offering simplified system assembly and thermal management.

**Features:**

- Low ESW(off)
- Aluminum Nitride Isolation
- Discrete Super-Fast Recovery Free-Wheel Silicon Carbide Schottky Diode**
- Low Internal Inductance
- 2 Individual Switches per Module
- Isolated Baseplate for Easy Heat Sinking
- Copper Baseplate

**Applications:**

- Energy Saving Power Systems such as:  
Fans; Pumps; Consumer Appliances
- High Frequency Type Power Systems such as:  
UPS; High Speed Motor Drives; Induction Heating; Welder; Robotics
- High Temperature Power Systems such as:  
Power Electronics in Electric Vehicle and Aviation Systems

**Outline Drawing and Circuit Diagram**

Dimensions	Inches	Millimeters
A	4.32	109.8
B	2.21	56.1
C	0.71	18.0
D	3.70±0.02	94.0±0.5
E	2.026	51.46
F	3.17	80.5
G	1.96	49.8
H	1.00	25.5
K	0.87	22.0
L	0.266	6.75
M	0.26	6.5
N	0.59	15.0
P	0.586	14.89

Dimensions	Inches	Millimeters
Q	0.449	11.40
R	0.885	22.49
S	1.047	26.6
T	0.15	3.80
U	0.16	4.0
V	0.30	7.5
W	0.045	1.15
X	0.03	0.8
Y	0.16	4.0
Z	0.47	12.1
AA	0.17 Dia.	4.3 Dia.
AB	0.10 Dia.	2.5 Dia.
AC	0.08 Dia.	2.1 Dia.

**QID1210005**

**Split Dual Si/SiC Hybrid IGBT Module**

100 Amperes/1200 Volts

**Absolute Maximum Ratings,  $T_j = 25^\circ\text{C}$  unless otherwise specified**

Ratings	Symbol	QID1210005	Units
Junction Temperature	$T_j$	-40 to 150	$^\circ\text{C}$
Storage Temperature	$T_{stg}$	-40 to 150	$^\circ\text{C}$
Collector-Emitter Voltage (G-E Short)	$V_{CES}$	1200	Volts
Gate-Emitter Voltage (C-E Short)	$V_{GES}$	$\pm 20$	Volts
Collector Current ( $T_C = 25^\circ\text{C}$ )	$I_C$	100*	Amperes
Peak Collector Current	$I_{CM}$	200*	Amperes
Emitter Current** ( $T_C = 25^\circ\text{C}$ )	$I_E$	80*	Amperes
Repetitive Peak Emitter Current ( $T_C = 25^\circ\text{C}$ , $t_p = 10\text{ms}$ , Half Sine Pulse)**	$I_{EM}$	455*	Amperes
Maximum Collector Dissipation ( $T_C = 25^\circ\text{C}$ , $T_j \leq 150^\circ\text{C}$ )	$P_C$	730	Watts
Mounting Torque, M6 Mounting	—	40	in-lb
Weight	—	270	Grams
Isolation Voltage (Main Terminal to Baseplate, AC 1 min.)	$V_{ISO}$	2500	Volts

**IGBT Electrical Characteristics,  $T_j = 25^\circ\text{C}$  unless otherwise specified**

Characteristics	Symbol	Test Conditions	Min.	Typ.	Max.	Units
Collector-Cutoff Current	$I_{CES}$	$V_{CE} = V_{CES}$ , $V_{GE} = 0\text{V}$	—	—	1.0	mA
Gate Leakage Current	$I_{GES}$	$V_{GE} = V_{GES}$ , $V_{CE} = 0\text{V}$	—	—	0.5	$\mu\text{A}$
Gate-Emitter Threshold Voltage	$V_{GE(th)}$	$I_C = 10\text{mA}$ , $V_{CE} = 10\text{V}$	4.5	6.0	7.5	Volts
Collector-Emitter Saturation Voltage	$V_{CE(sat)}$	$I_C = 100\text{A}$ , $V_{GE} = 15\text{V}$ , $T_j = 25^\circ\text{C}$	—	5.0	6.5	Volts
		$I_C = 100\text{A}$ , $V_{GE} = 15\text{V}$ , $T_j = 125^\circ\text{C}$	—	5.0	—	Volts
Total Gate Charge	$Q_G$	$V_{CC} = 600\text{V}$ , $I_C = 100\text{A}$ , $V_{GE} = 15\text{V}$	—	450	—	nC
Input Capacitance	$C_{ies}$		—	—	16	nf
Output Capacitance	$C_{oes}$	$V_{CE} = 10\text{V}$ , $V_{GE} = 0\text{V}$	—	—	1.3	nf
Reverse Transfer Capacitance	$C_{res}$		—	—	0.3	nf
Inductive	Turn-on Delay Time	$t_{d(on)}$	—	—	TBD	ns
	Rise Time	$t_r$				
Switch	Turn-off Delay Time	$t_{d(off)}$	—	—	TBD	ns
	TimeFall Time	$t_f$				

\* Pulse width and repetition rate should be such that device junction temperature ( $T_j$ ) does not exceed  $T_{j(max)}$  rating.

\*\*Represents characteristics of the anti-parallel, emitter-to-collector silicon carbide Schottky diode (FWDI).

**QID1210005**

**Split Dual Si/SiC Hybrid IGBT Module**

100 Amperes/1200 Volts

**Reverse Schottky Diode Characteristics,  $T_j = 25\text{ }^\circ\text{C}$  unless otherwise specified**

Characteristics	Symbol	Test Conditions	Min.	Typ.	Max.	Units
Diode Forward Voltage	$V_{FM}$	$I_F = 80\text{A}, V_{GS} = -5\text{V}$	—	1.6	2.0	Volts
		$I_F = 80\text{A}, V_{GS} = -5\text{V}, T_j = 175^\circ\text{C}$	—	2.5	3.2	Volts
Diode Reverse Current	$I_R$	$V_R = 1200\text{V}$	—	140	800	$\mu\text{A}$
		$V_R = 1200, T_j = 150^\circ\text{C}$	—	260	1600	$\mu\text{A}$
Diode Capacitive Charge	$Q_C$	$V_R = 1200\text{V}, I_F = 80\text{A}, di/dt = 800\text{A}/\mu\text{s}$	—	520	—	nC

**Thermal and Mechanical Characteristics,  $T_j = 25\text{ }^\circ\text{C}$  unless otherwise specified**

Characteristics	Symbol	Test Conditions	Min.	Typ.	Max.	Units
Thermal Resistance, Junction to Case	$R_{th(j-c)Q}$	Per IGBT 1/2 Module,	—	—	0.17	$^\circ\text{C}/\text{W}$
		$T_C$ Reference Point Under Chips				
Thermal Resistance, Junction to Case	$R_{th(j-c)D}$	Per FWDi 1/2 Module, $T_C$ Reference	—	—	0.304	$^\circ\text{C}/\text{W}$
		$T_C$ Reference Point Under Chips				
Contact Thermal Resistance	$R_{th(c-f)}$	Per 1/2 Module, Thermal Grease Applied	—	0.04	—	$^\circ\text{C}/\text{W}$
External Gate Resistance	$R_G$		3.1	—	31	$\Omega$
Internal Inductance	$L_{int}$	IGBT Part	—	10	—	nH

**QID1210005**  
**Split Dual Si/SiC Hybrid IGBT Module**  
 100 Amperes/1200 Volts

**OUTPUT CHARACTERISTICS (TYPICAL)**

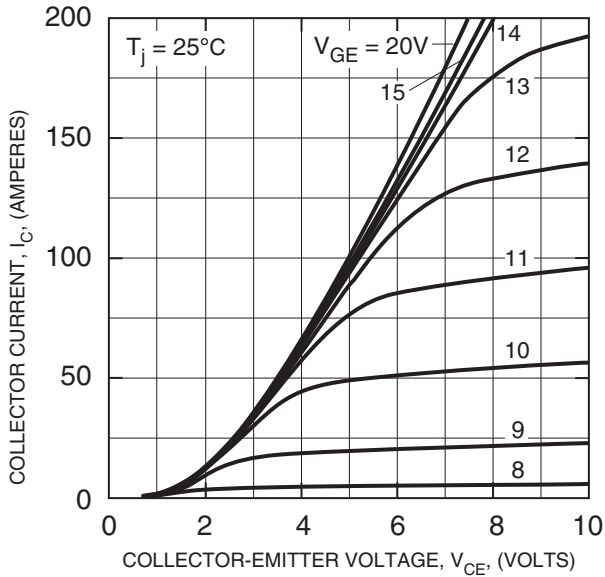

**TRANSFER CHARACTERISTICS (TYPICAL)**

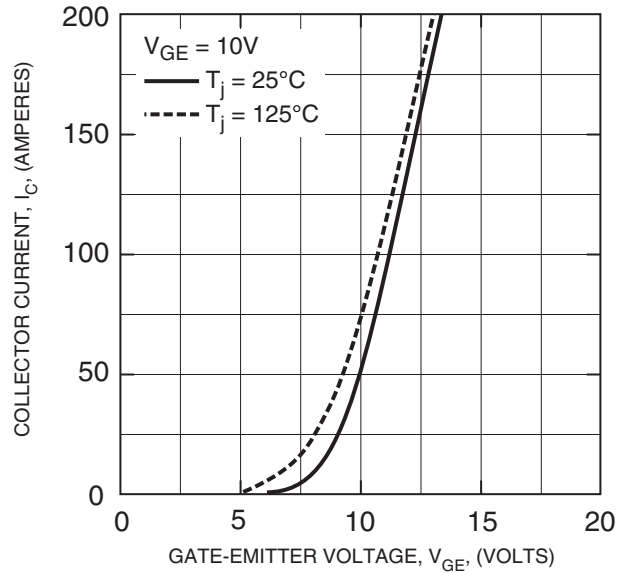

**COLLECTOR-EMITTER SATURATION VOLTAGE CHARACTERISTICS (TYPICAL)**

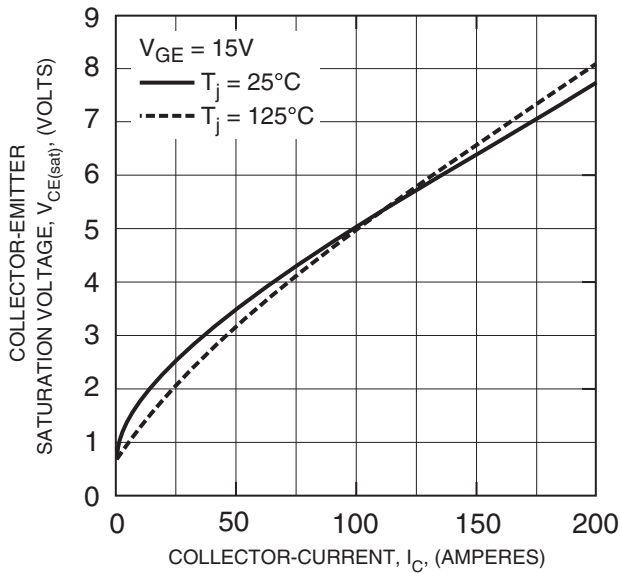

**COLLECTOR-EMITTER SATURATION VOLTAGE CHARACTERISTICS (TYPICAL)**

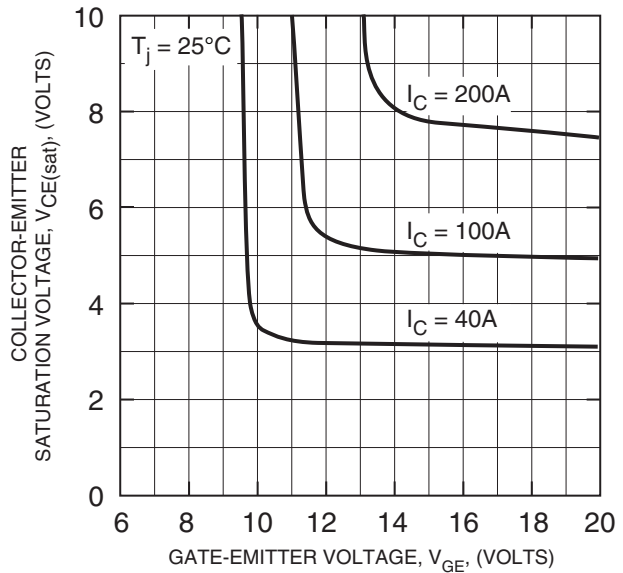

**QID1210005**  
**Split Dual Si/SiC Hybrid IGBT Module**  
 100 Amperes/1200 Volts

**FREE-WHEEL SCHOTTKY DIODE FORWARD CHARACTERISTICS (TYPICAL)**

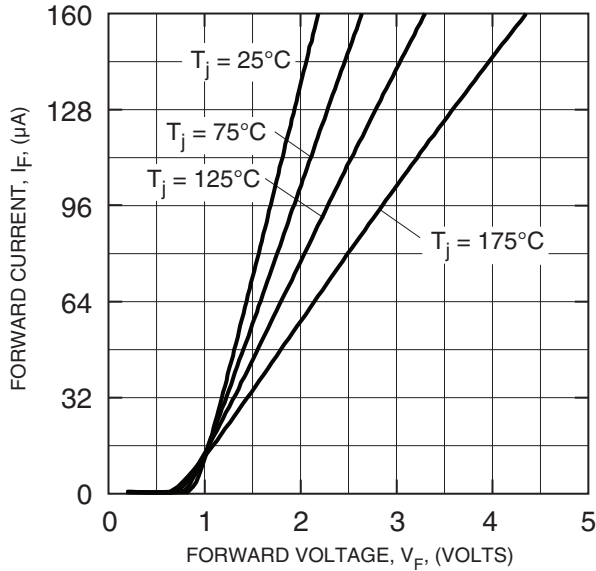

**FREE-WHEEL SCHOTTKY DIODE REVERSE CHARACTERISTICS (TYPICAL)**

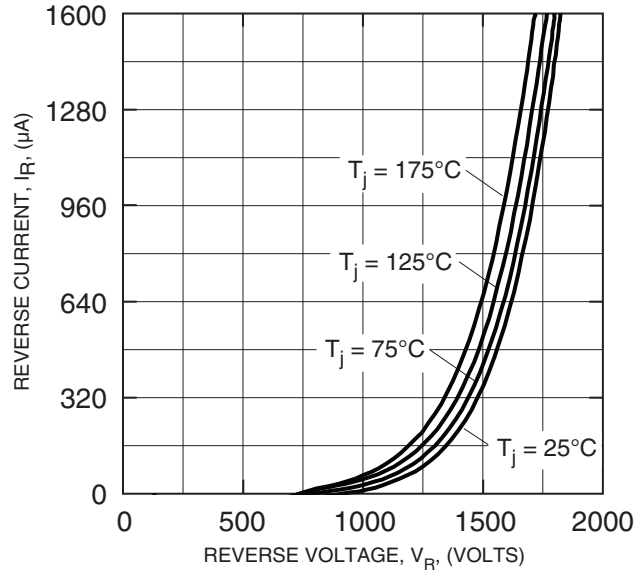

**CAPACITANCE VS.  $V_{CE}$  (TYPICAL)**

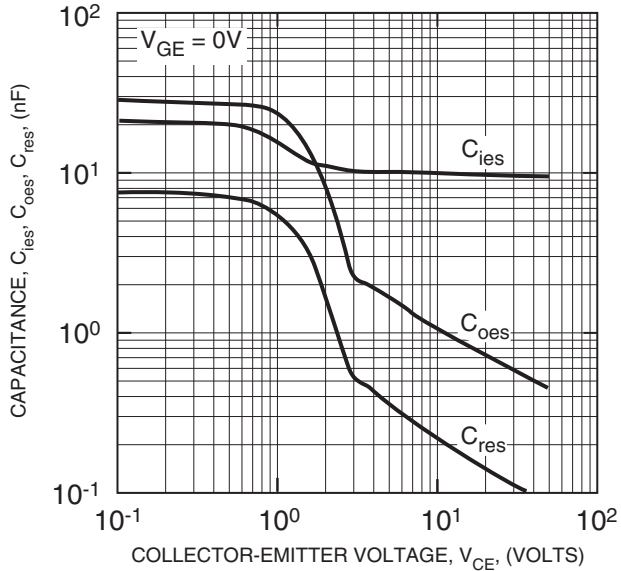

**HALF-BRIDGE SWITCHING CHARACTERISTICS (TYPICAL)**

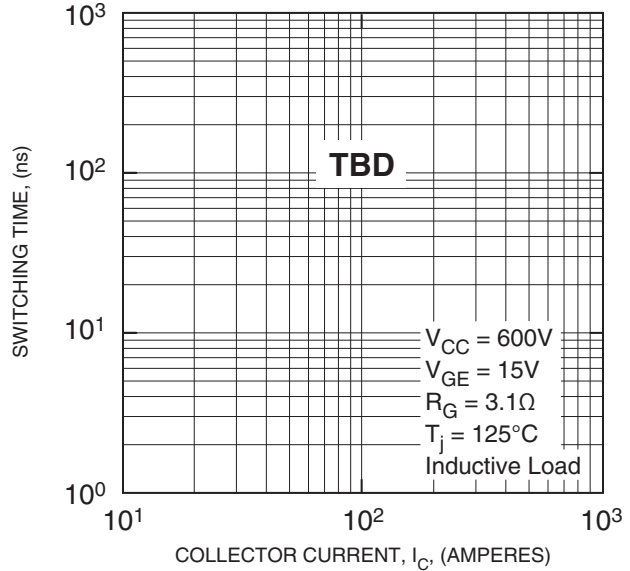

**QID1210005**  
**Split Dual Si/SiC Hybrid IGBT Module**  
 100 Amperes/1200 Volts

**GATE CHARGE VS.  $V_{GE}$**

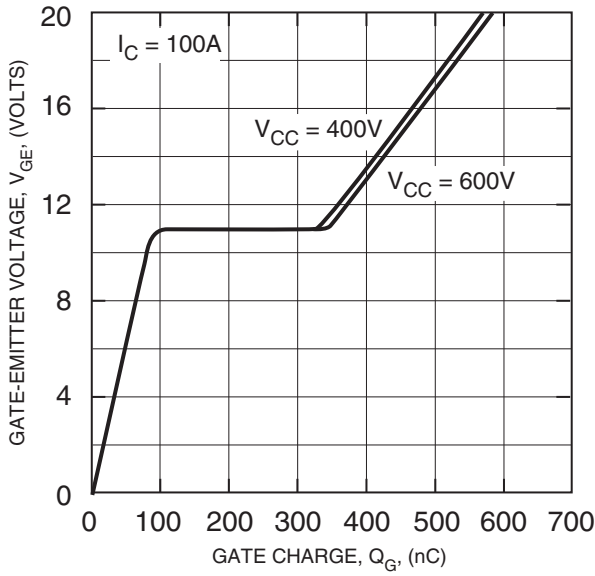

**SWITCHING LOSS VS. COLLECTOR CURRENT (TYPICAL)**

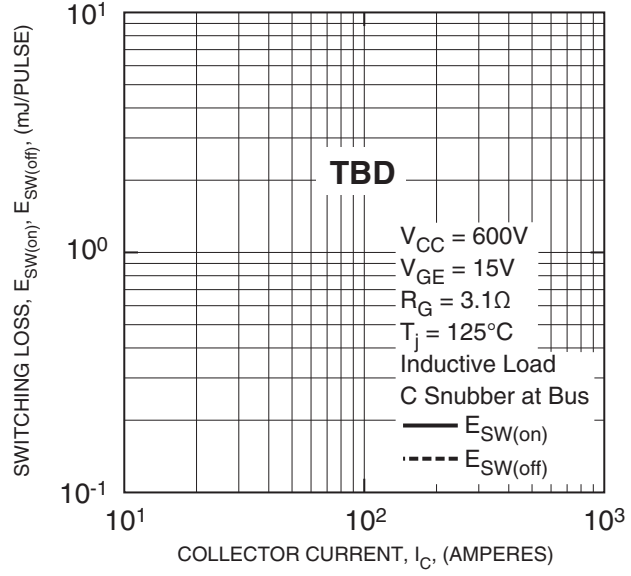

**SWITCHING LOSS VS. GATE RESISTANCE (TYPICAL)**

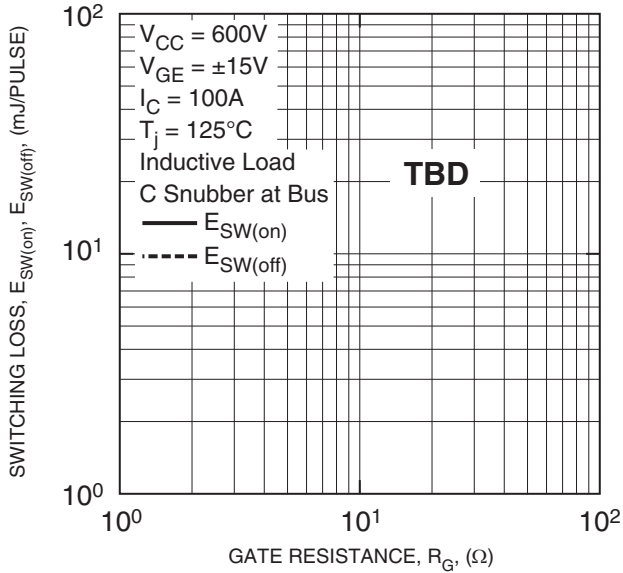

**REVERSE RECOVERY SWITCHING LOSS VS. EMITTER CURRENT (TYPICAL)**

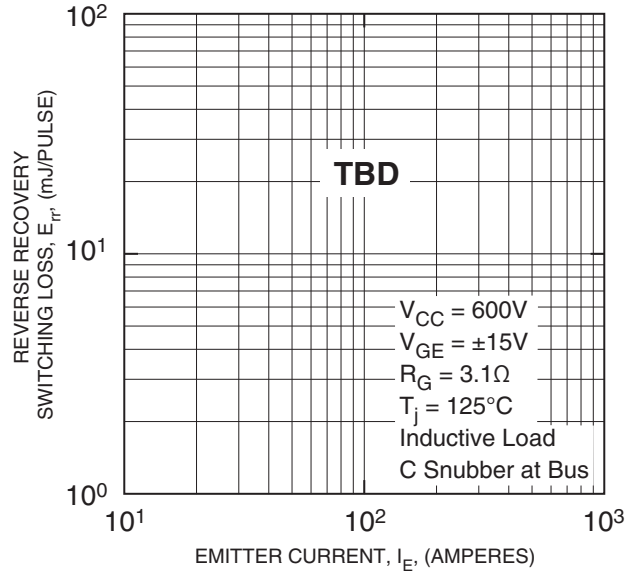

**QID1210005**  
**Split Dual Si/SiC Hybrid IGBT Module**  
 100 Amperes/1200 Volts

**REVERSE RECOVERY SWITCHING LOSS VS. GATE RESISTANCE (TYPICAL)**

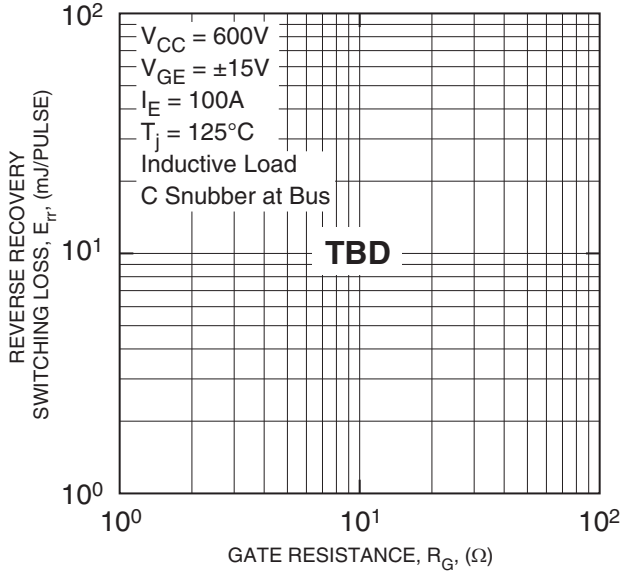

**TRANSIENT THERMAL IMPEDANCE CHARACTERISTICS (IGBT & FWDi)**

